

WALL + FLOOR FLANGES

LINEAR DRAINAGE



- + 100mm and 65mm wide grates.
- + Custom outlet size and position.
- + Product Specification Sheets.
- + Choose a designer grate or tile insert.
- + Made to custom flange requirements.
- + Custom flange made to suit tile depth.



AR



TR

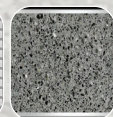

Ti



PS



PPS



PAS

Stormtech®



Choose your
design + finish



WALL + TILE FLANGES

The F Series solves the complexities of today's building requirements with custom wall and floor flanges. Available with Stormtech's exclusive range of designer grates, tile inserts and colour finishes.

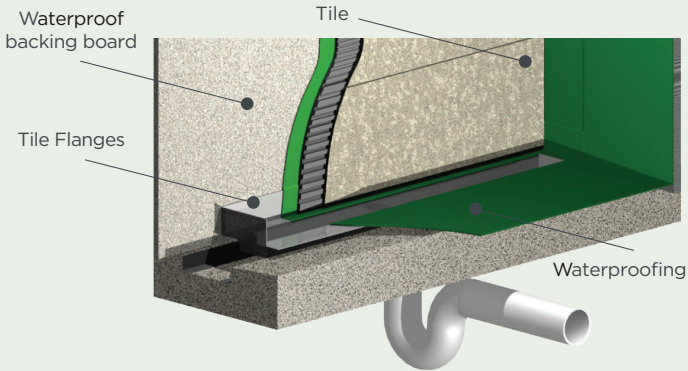

PROFILES + TYPICAL INSTALLATION

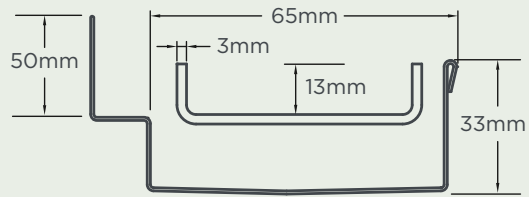

65mm TILE FLANGE
With Tile Insert (Ti)

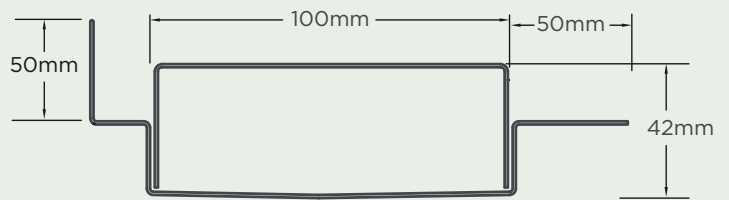

100mm TILE FLANGE

100 RANGE - 100mm x 42mm

Available DN sizes:
DN40, DN50, DN65, DN80 + DN100 (Default) *

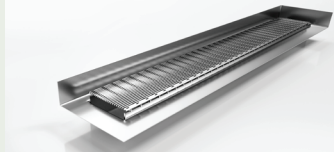

100ARiMTLF
Premium Grate

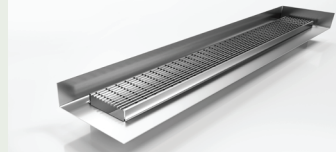

100TRiMTLF
Standard Grate

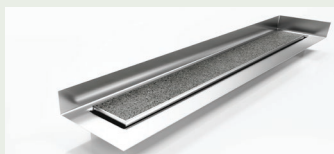

100TiMTLF
Tile Insert

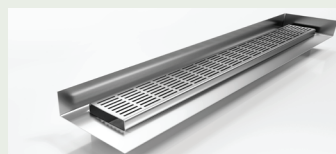

100PSiMTLF
Punched Slot



100PPSiMTLF
Punched Perpendicular Design



100PASiMTLF
Punched Angle Slot Design

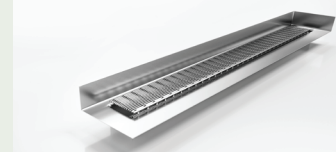

65ARiMTLF
Premium Grate

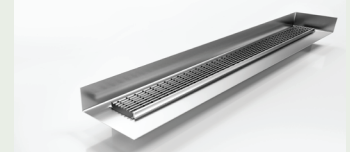

65TRiMTLF
Standard Grate

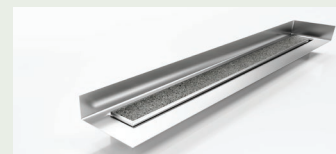

65TiMTLF
Tile Insert

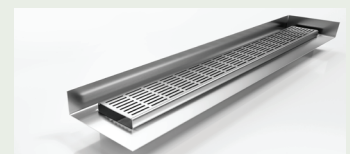

65PSiMTLF
Punched Slot



65PPSiMTLF
Punched Perpendicular Design



65PASiMTLF
Punched Angle Slot Design

Visit stormtech.com.au for detailed assembly and installation information or scan QR code.



DISTRIBUTORS & STOCKISTS

+ To find a distributor near you, please visit our website or call our office.

TECHNICAL INFORMATION

+ We provide product information & CAD files for download from our website.

Stormtech Pty Ltd 22 Norfolk Avenue, South Nowra, NSW 2541 Australia.
Phone 1300 653 403 | Email info@stormtech.com.au

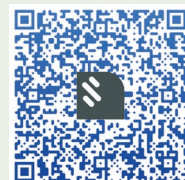

SCAN ME

